

**Danfoss AK-SM 720 Driver JACE8000/MAC36/Supervisor  
ALVASYS-DR-AKIP10 - ALVASYS driver for Device Network Interconnected  
Protocol  
Suitable for Danfoss AK-SM 720 System Manager and Danfoss New Generation  
devices. Software installation and configuration manual.**

Ver: 2.3.0.1

Date: 23.8.2022

# 1 History

Filename: ALVASYS-DR-AKIP_v2.3.0.1.odt			
Rev.	Date	Author	Description
1.0	11.09.2020	S. Strapparava	First draft
1.0.3	02.10.020	S. Strapparava	1.0.3
2.2.1.0	21.03.2021	S. Strapparava	2.2.1.0
2.3.0.0	06.04.2021	S. Strapparava	2.3.0.0
2.3.0.1	29/04/21	S. Strapparava	Changes on configuration interface Chapter 4 – Driver configuration Capter 6 – How to create a simulator
	23.8.2022	M.Meriano	Update driver for N4.7+N4.8+N4.9+N4.10+

# 2 Index

1History.....	2
2Index.....	2
3Confidentiality Notice.....	3
4Introduction.....	3
Requirements.....	3
Module.....	3
Compatibility.....	4
5Installing the software.....	4
Installing the driver into the JACE/HAWK unit.....	5
6Example of installation and configuration.....	6
7Danfoss AK-SM 720 System Manager configuration.....	7
8Driver configuration.....	9
9Discovering devices.....	13
10Discovering points.....	14
11Configuration.....	15



## 3 Confidentiality Notice

The information contained in this document is confidential information of Alvasys automation ag (“ALVASYS”). Such information and the software described herein, is furnished under license agreement and may be used only in accordance with that agreement.

The information contained in this document is provided solely for use by ALVASYS employees, licenses and system owners. Contents of this document are not to be released to or reproduced for anyone else.

While every effort has been made to assure the accuracy of this document, ALVASYS is not responsible for damages of any kind, including without limitation consequential damages, arising from the application of the information contained herein. Information and specifications published here current as of the date to this publication and are subject to change without notice.

This document may be copied by parties who are authorised to distribute ALVASYS products in connection with distribution of those products, subject to the contracts that authorize such distribution. It may not otherwise, in whole or in part, be copied, photocopied, reproduced, translated or reduced to any electronic medium or machine-readable form without prior written consent from ALVASYS.

## 4 Introduction

### Requirements

- Niagara 4.x ( $\geq 4.7$ )
- A license to use the ALVASYS-DR- AKIP driver. Other device limit or proxy-point limits may apply to your license. For license details and options, see the ALVASYS-DR-AKIP price list.

### Module

The ALVASYS-DR-SMSIP Driver is contained in two files:

- `ALVASYS-DR-AKIP-rt.jar`

## Compatibility

### Platforms

The ALVASYS-DR-SMSIP driver runs on Niagara 4.x ( $\geq 4.4$ ) platforms.

### Tested versions

Niagara 4.9.x

## 5 Installing the software

Installing the ALVASYS-DR-SMSIP driver is simple.

It requires a basic knowledge of the Tridium Niagara 4 and execute a few steps as described hereafter.

The driver, a Java “.jar” executable file, is usually shipped in a zip file.

Its name is generated according to the following structure:

**ALVASYS-DR-AKIP-rt\_<version number>** ( i.e. ALVASYS-DR-AKIP-rt\_v1.0.3.1)

The number of the version characterises the features included in the driver and may vary from time to time.

An additional text file is normally added to the zip file, in order to explain the main features of the release.

Its name may appear as follow:

**Note on SwVer <version number>** ( i.e. Note on SwVer 1.0.3)

Installing the driver on your PC

The following procedures describe how to set-up the driver.

Step 1	First of all unzip the files which contains the driver and technical notes.
Step 2	Rename the files, changing theirs name into <b>ALVASYS-DR-AKIP-rt</b> and <b>ALVASYS-DR-AKIP-wb</b> Extension <b>.jar</b> should remain as well.
Step 3	Copy the two <b>jar</b> files into the <b>modules</b> directory of your Niagara <b>Work Bench</b> .
Step 4	Restart your <b>Work Bench</b> .
Step 5	After restarting, the file should appears in the list of available software, which can be shown clicking on the <b>Software Manager</b> section of the <b>Platform</b> of your <b>Work Bench</b> .

## Installing the driver into the JACE/HAWK unit

Step 1	Through the <b>Work Bench</b> get connected to a JACE/HAWK running unit.
Step 2	Transfer the <b>ALVASYS-DR-AKIP</b> module into the unit under the folder <b>modules</b> .
Step 3	<p>This can be done by activating the standard Tridium procedure for software upgrading or simply copying the <b>jar</b> files by the <b>File Transfer Client</b> procedure, available under the list of the <b>Platform</b> options in your <b>Work Bench</b>.</p> <p>Destination directory inside the Jace8000 is: <b>/opt/niagara/modules</b></p> <p>For further details on how to transfer files from <b>Work Bench</b> to JACE/HAWK units, refer to the official Tridium documentation.</p>
Step 4	After copying the driver into the JACE/HAWK unit, force a reboot.

## 6 Example of installation and configuration

In order to fully explaining the hardware/software installation, the examples included in this manual refer to a system running at ALVASYS testing labs.

The following figures show the network architecture and physical connections:

Example of Networking Configuration  
(SSI testing Lab)

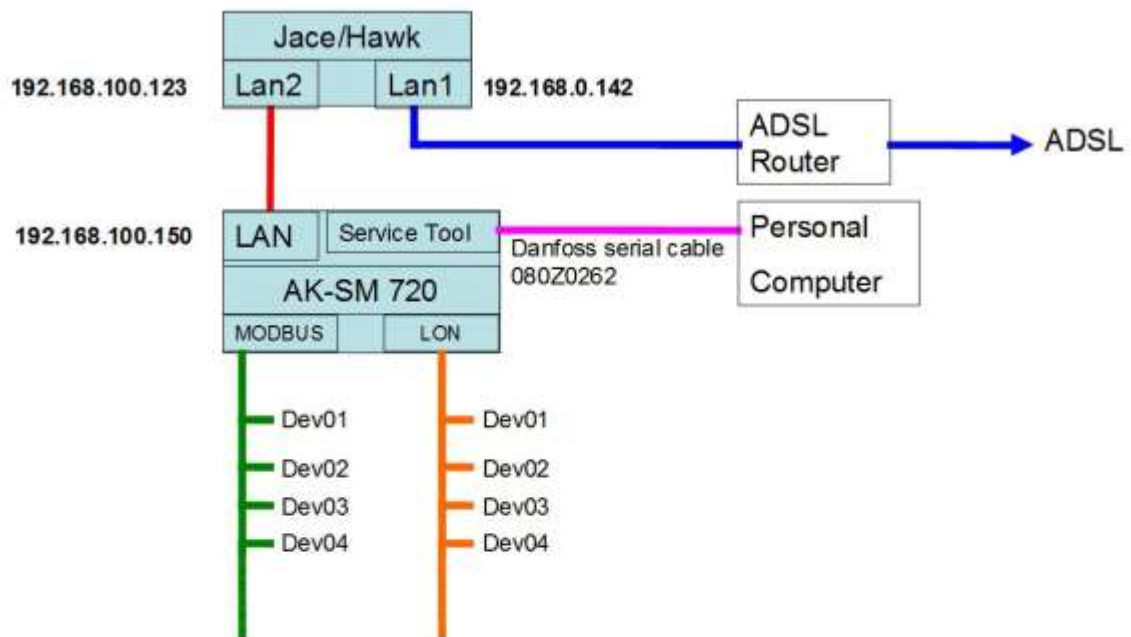

## 7 Danfoss AK-SM 720 System Manager configuration

Before proceeding with the configuration of the driver, a re-direction of the communication messages has to be completed at AK-SM 720 level.

According to the proposed scheme, the following figures show how to change the destination of the AK-SM 720 messages:

1. Get connected to the AK-SM 720 by means of the Danfoss Service Tool software and open the Configuration Menu:

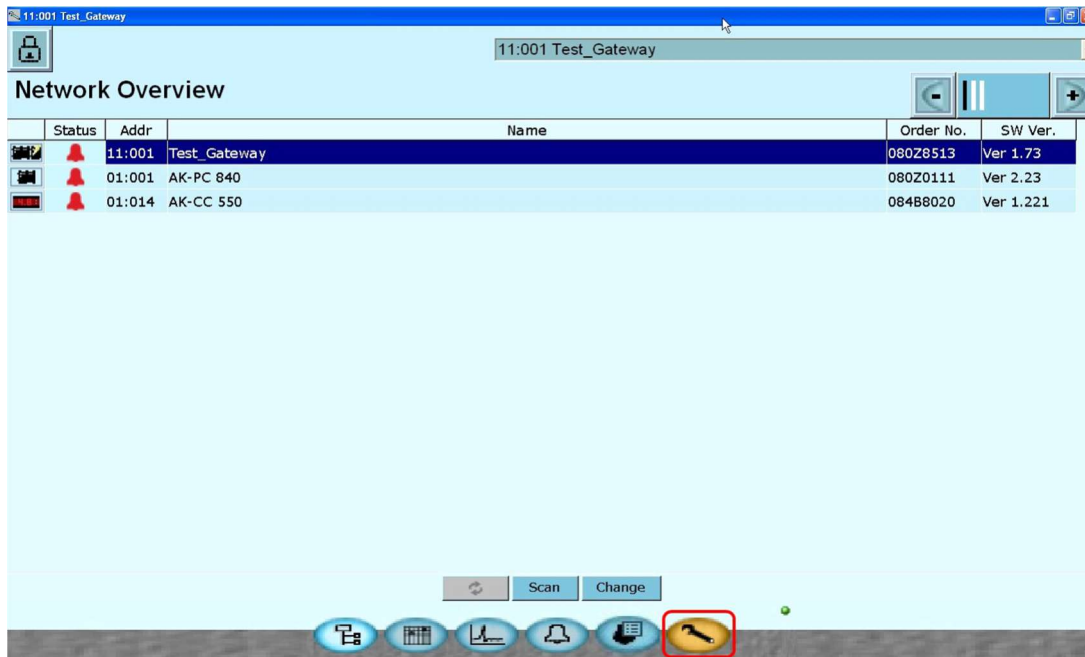

2. Select the Destinations options

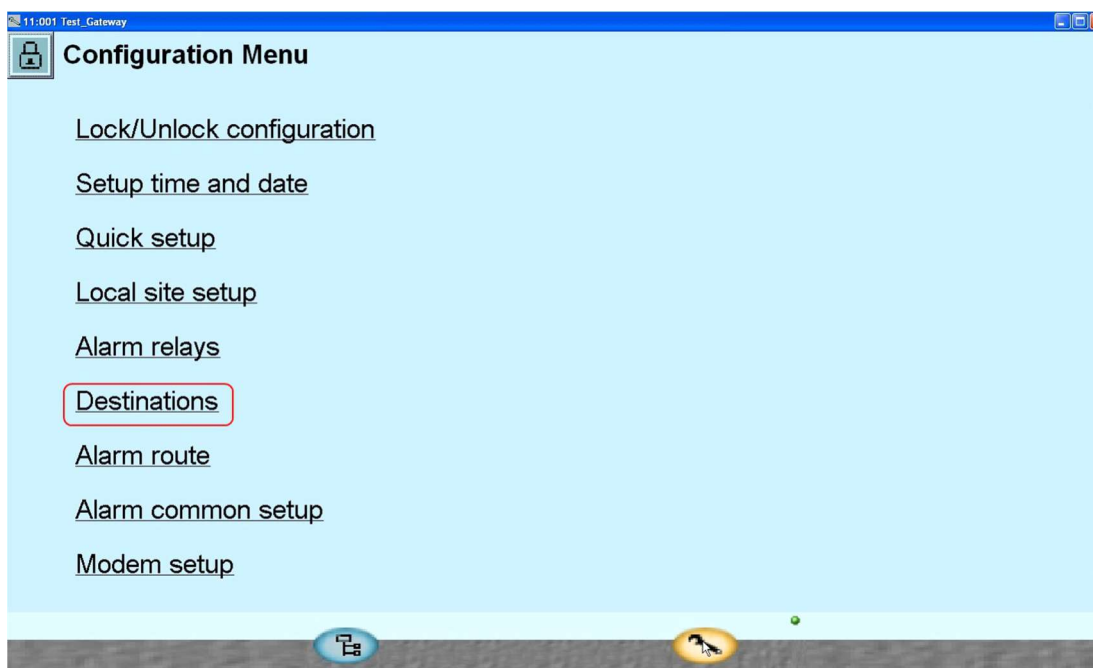



3. Define a new destination according to the Danfoss rules (Destination 1 in the proposed example)

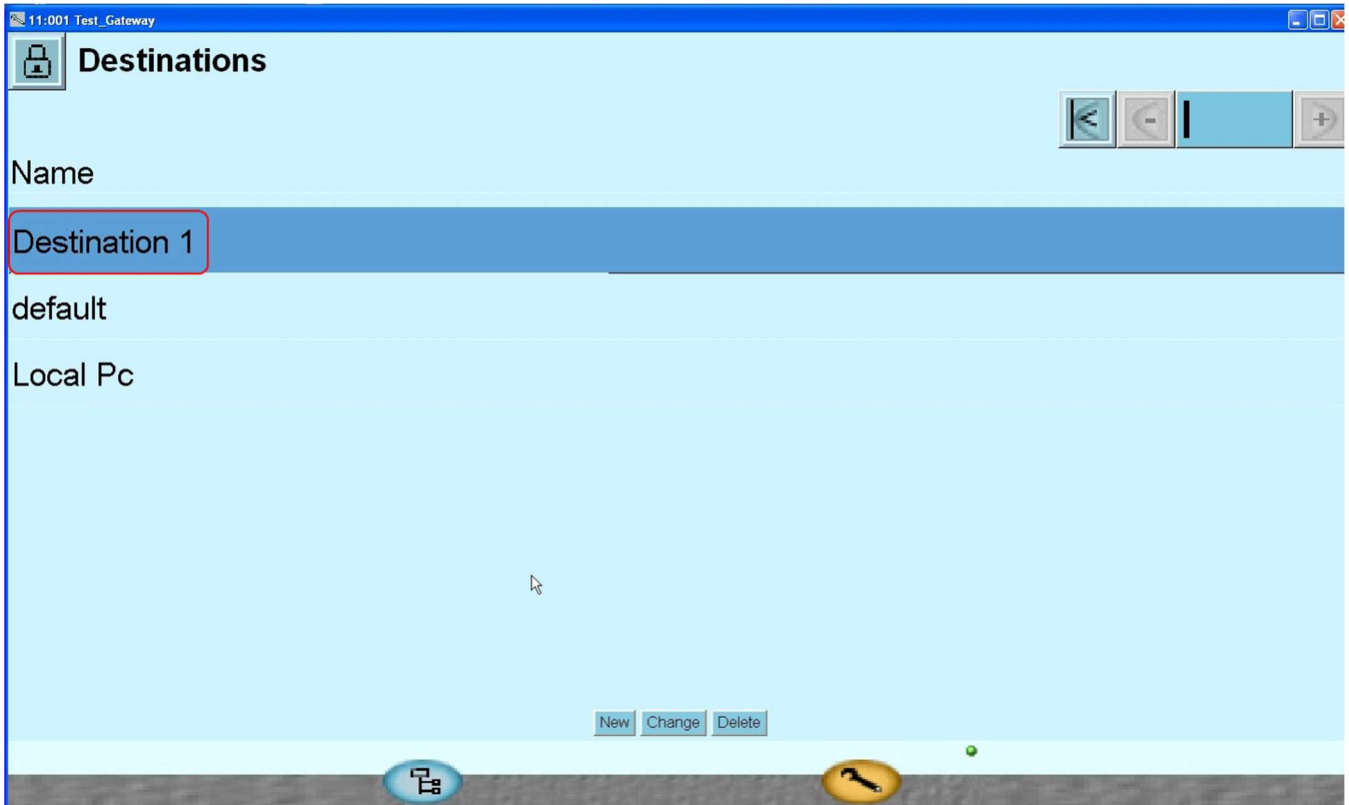

4. By means of the “Change” button, modify the various options according to the following figure:

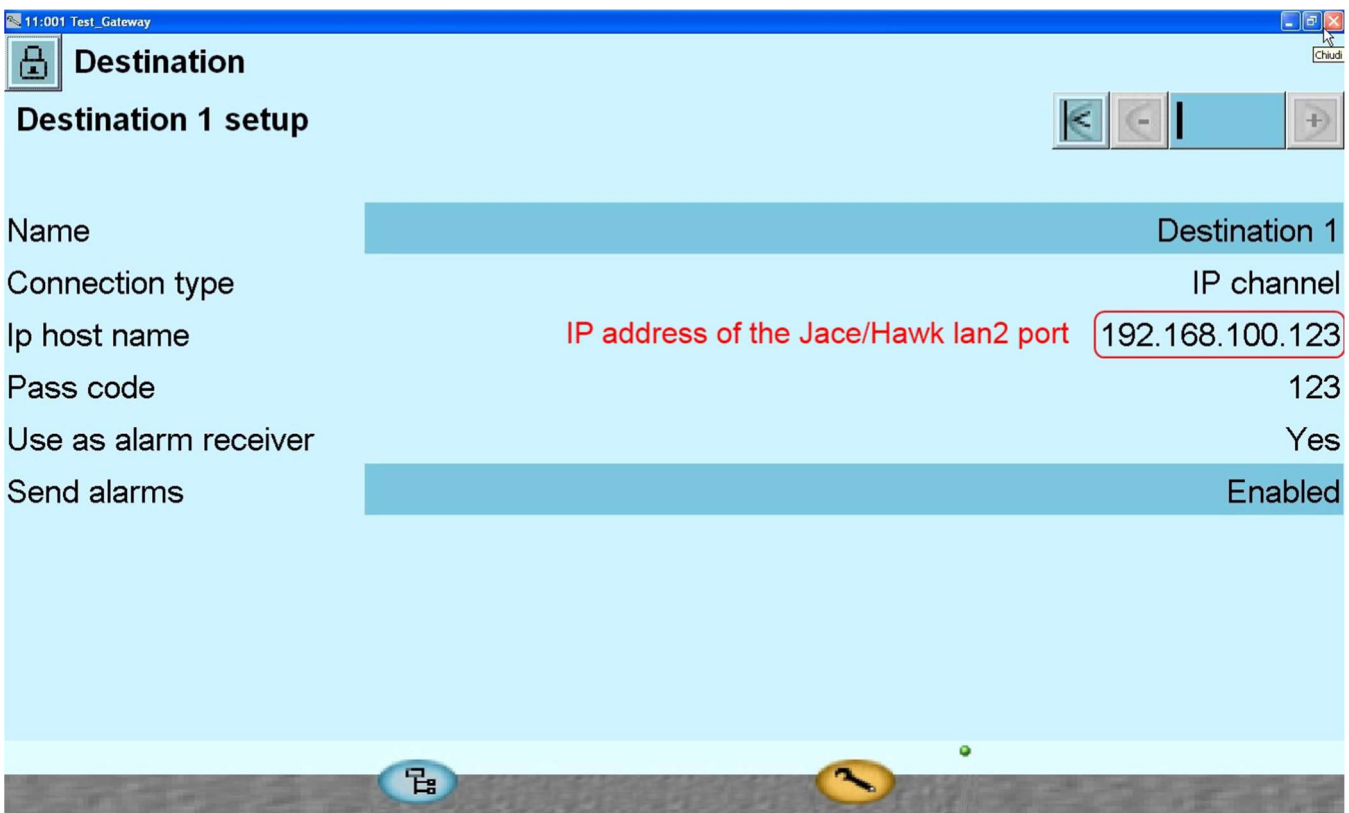

## 8 Driver configuration

Installing the Sse DNIP Network

The first step of the driver configuration is the installation of the “SseDnipGatewayNetwork” under the station running in the Jace/Hawk unit.

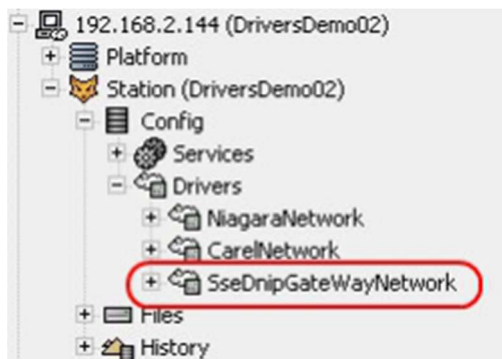

A simple way to complete this task is to open the palette named “sseDnip” (see figure below), select the “SseDnipGatewayNetwork” component and drag and drop it under the “Drivers” folder of the running station.

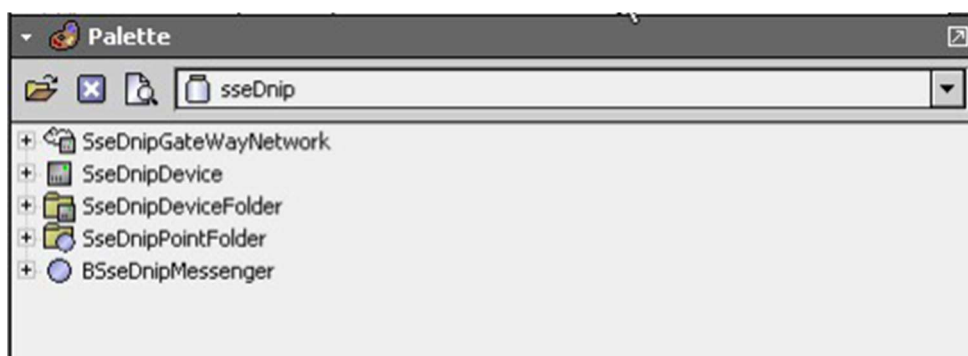

As alternative, the standard method of adding network can be adopted, selecting the Driver folder of the running station and clicking the “New” button provided for networks addition. Then follow the standard Tridium rules to complete the task.

Configuring the driver details

To proceed with this task, right click on the “SseDnipGatewayNetwork” and open its “Property Sheet”.

This will appear as the following figure:

SseDnipGateWayNetwork

- Enabled true
- Fault Cause [text box]
- Health Ok [01 feb 2013 13:21 CET]
- Alarm Source Info Alarm Source Info
- Monitor Ping Monitor
- Tuning Policies Tuning Policy Map
  - Default Policy Tuning Policy
    - Min Write Time 00000h 00m 00s [0ms - +inf]
    - Max Write Time 00000h 00m 00s [0ms - +inf]
    - Write On Start false
    - Write On Up false
    - Write On Enabled false
    - Stale Time 00000h 00m 00s [0ms - +inf]
- Background Processor Ddf Worker
- Communicator Sse Dnip Communicator
  - Transmitter Ddf Tcp Transmitter
  - Receiver Sse Dnip Receiver
    - Response Timeout 00000h 00m 05.000s [0ms - +inf]
    - Num Frames Received 249211 [0 - max]
  - Transaction Manager Ddf Single Transaction Mgr
  - Poll Scheduler Ddf Poll Scheduler
  - Unsolicited Mgr Ddf Null Unsolicited Mgr
  - Network Interface [\*\*\* Default Local Host \*\*\*]
  - Tcp Ip Comm 192.168.100.150:1041
    - Destination Address Ddf Ip Address Port
      - Ip Address 192.168.100.150 IP address of the AK720 gateway
      - Ip Port 1041
    - Socket Connection Timeout 00000h 00m 30.000s [1ms - +inf]
- Discovery Preferences Sse Dnip Device Discovery Preferences
  - Gateway Address 11:001 Network address of the AK 720 gateway
  - Site Name HM SM720
  - Destination DanfossService

The values proposed refer to the units running in our lab, according to the proposed scheme, shown in par. 2 of this document. Be sure that your configuration complies to the highlighted options and save it.

## Configuring the TCP/IP options in the Jace/Hawk unit

The following settings have to be defined in order to use the second LAN port of the Jace/Hawk unit to communicate with the AK-CC 720 via TCP/IP communication standard.

In order to do that, select the TCP/IP option under the Platform folder in the running Jace/Hawk.

Platform		14 objects
Name	Description	
Application Director	Control applications and access console output	
DDNS Configuration	Configure the way DDNS operates.	
Dialup Configuration	Configure the way the remote host uses dialup networking	
Distribution File Installer	Install distribution files to the remote host	
File Transfer Client	Transfer files to and from the remote host	
GPRS Modem Configuration	Configure and Monitor GPRS modem	
Lexicon Installer	Install lexicons to support additional languages	
License Manager	Manage licenses and certificates	
Platform Administration	Update the platform daemon's port or credentials, or set its date and time	
Sedona Manager	Install and manage Sedona applications	
Software Manager	Install software to the remote host	
Station Copier	Transfer stations to and from the remote host	
<b>TCP/IP Configuration</b>	<b>Manage the host's TCP/IP settings</b>	
Remote File System	The remote host's file system	

Configure the IP setting of the LAN 2 port of the Jace/Hawk unit, according the values of your network.

The values proposed hereafter refer to the example used in this document.

Hostname:   
 Hosts File:   
 DNS Domain:   
 IPv4 Gateway:   
 DNSv4 Servers:

**Interfaces**

**Interface 1**

ID: en0  
 Description: Onboard Ethernet Adapter en0  
 Physical Address: Unavailable  
 Adapter Enabled:  Enabled

IPv4 Settings

DHCPv4:  Enabled  
 IPv4 Address:   
 IPv4 Subnet Mask:   
 DHCPv4 Server: n/a  
 DHCPv4 Lease Granted: n/a  
 DHCPv4 Lease Expires: n/a

**Interface 2**

ID: en1  
 Description: Onboard Ethernet Adapter en1  
 Physical Address: Unavailable  
 Adapter Enabled:  Enabled

IPv4 Settings

IPv4 Address:   
 IPv4 Subnet Mask:

Save the settings.

At this stage a system reboot will be requested by the system.

After rebooting and if the settings are correct, you should get on "OK" status in the Health of the Network.

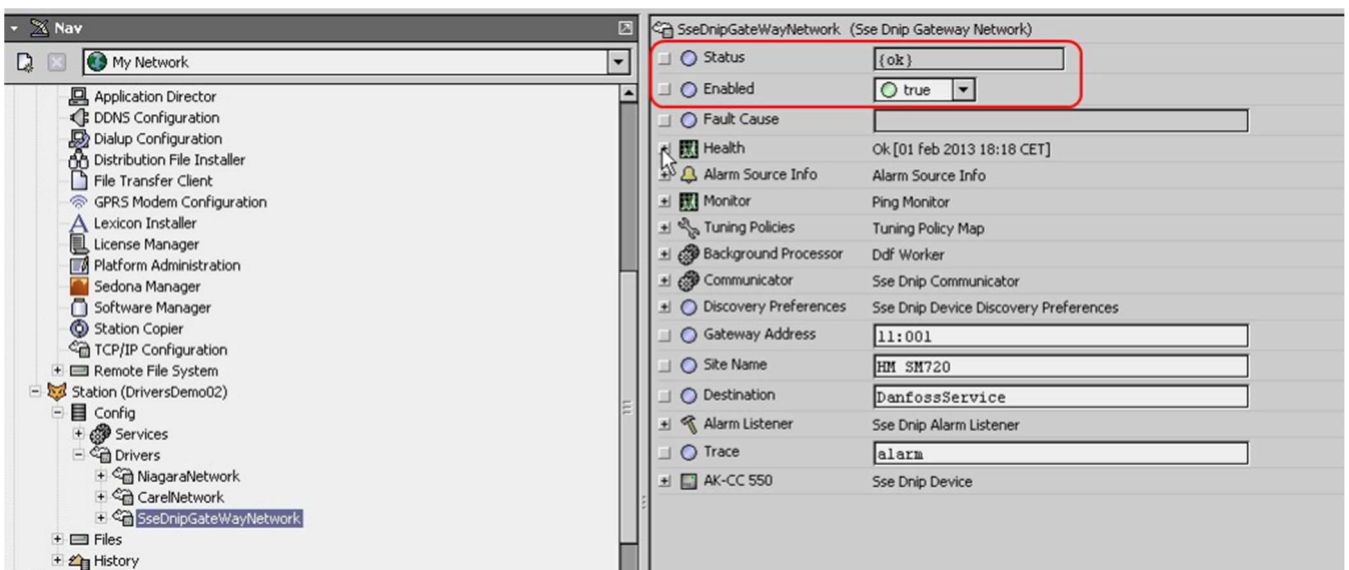
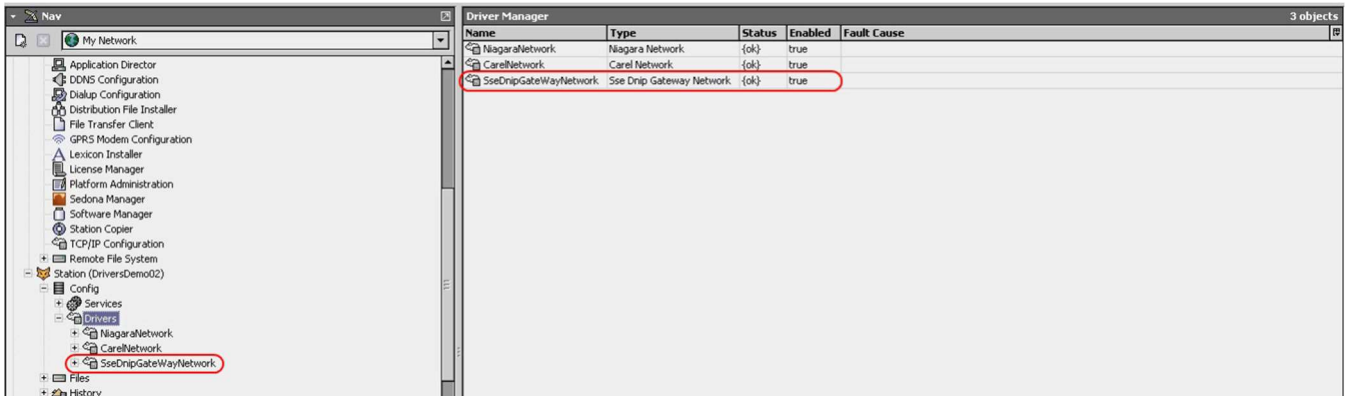

## 9 Discovering devices

After completing successfully the network configuration, a discovery of the devices connected to the network is possible. In order to complete this task, click on the “SseDnipGatewayNetwork” and select the push button marked

“Discovery”, as shown in the following pictures:

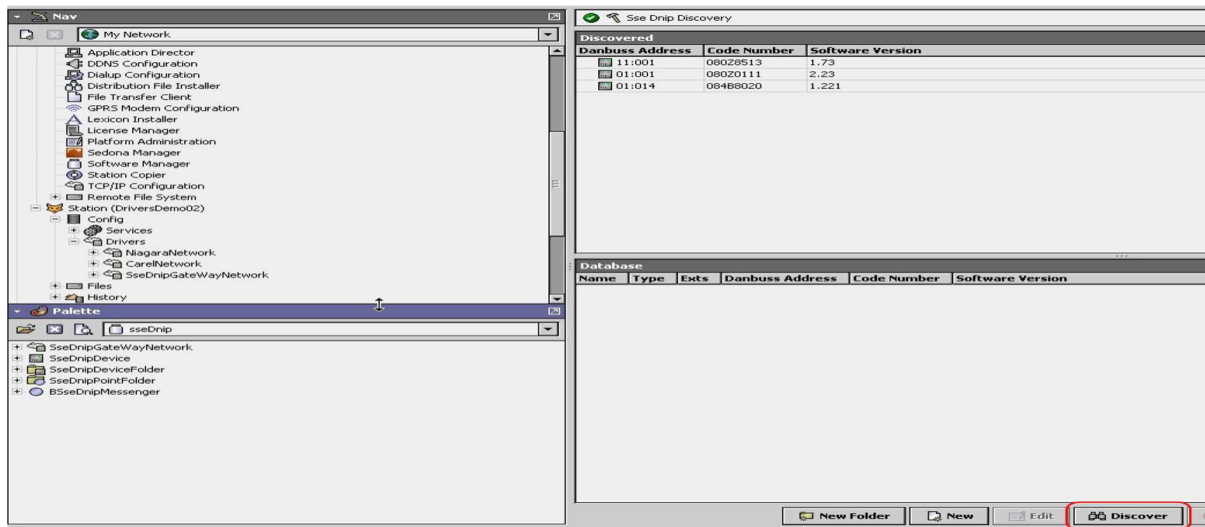

The discovered points can be added to the database of the Jace/Hawk unit as displayed:

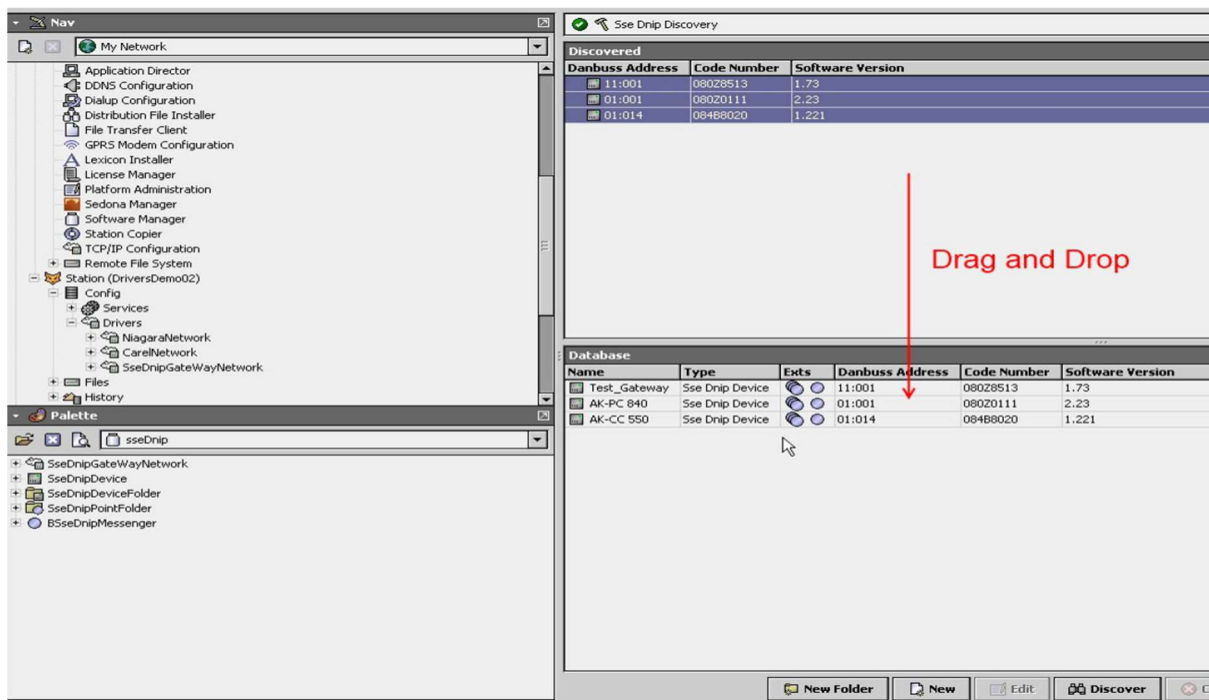

**IMPORTANT:** The driver is able to read and associate to any discovered device its own Network Address assigned in the Danfoss network, the original Danfoss product code number and the Danfoss software version running on it.

This is particularly useful while configuring huge sites because the process is totally automatic and error free.

Note: The driver discovers the gateway as well and classifies it automatically as such.



## 10 Discovering points

A similar process can be activated to discover points for each device added to the database.

For every discovered device, the driver creates a specific folder with sub-folders with the name of the discovered device. After opening the directory of the device, it is possible to see the sub-directories and in particular the one dedicated to points. The following figure is self explaining.

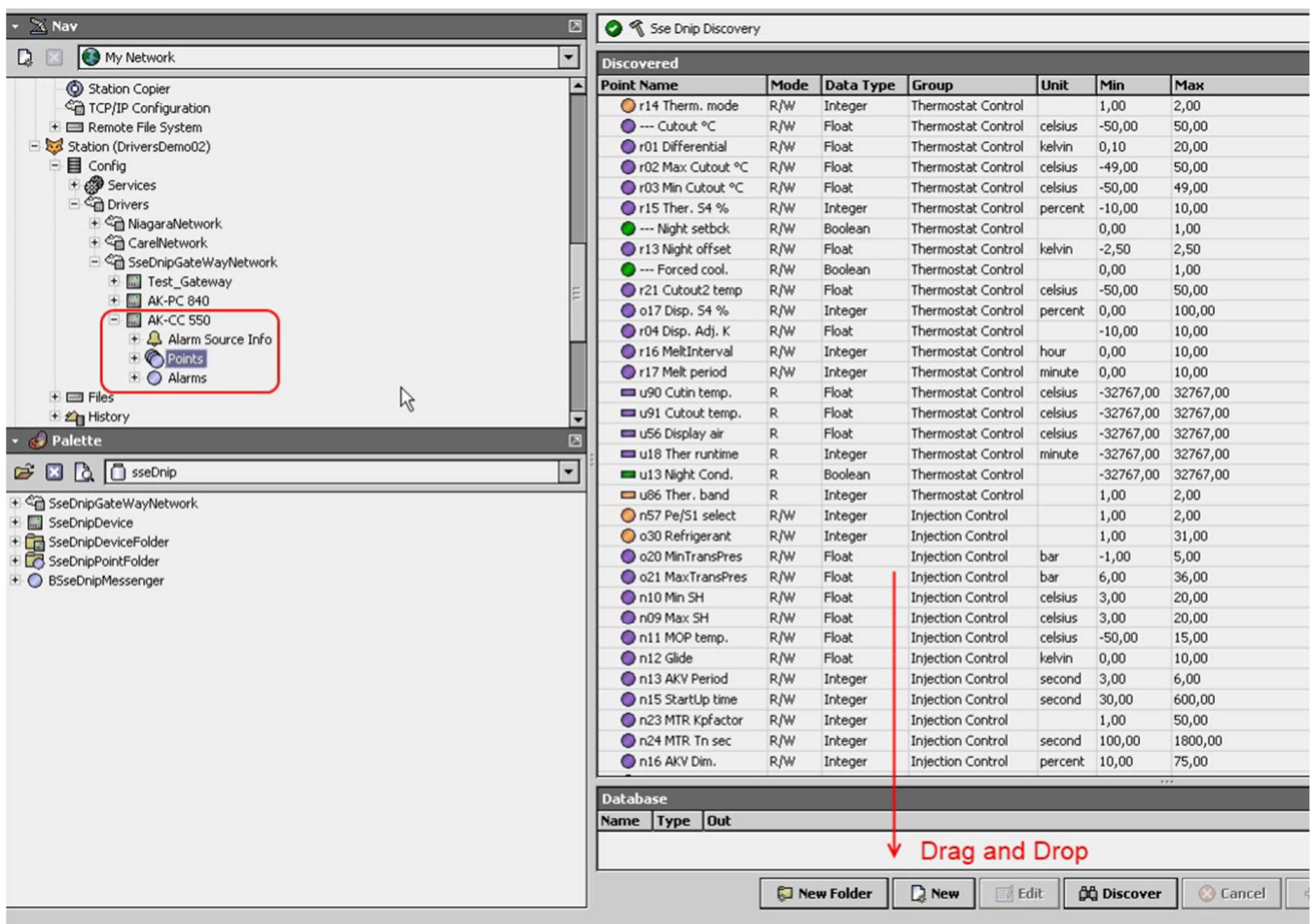

Point Name	Mode	Data Type	Group	Unit	Min	Max
r14 Therm. mode	R/W	Integer	Thermostat Control		1,00	2,00
--- Cutout °C	R/W	Float	Thermostat Control	celsius	-50,00	50,00
r01 Differential	R/W	Float	Thermostat Control	kelvin	0,10	20,00
r02 Max Cutout °C	R/W	Float	Thermostat Control	celsius	-49,00	50,00
r03 Min Cutout °C	R/W	Float	Thermostat Control	celsius	-50,00	49,00
r15 Ther. 54 %	R/W	Integer	Thermostat Control	percent	-10,00	10,00
--- Night setback	R/W	Boolean	Thermostat Control		0,00	1,00
r13 Night offset	R/W	Float	Thermostat Control	kelvin	-2,50	2,50
--- Forced cool.	R/W	Boolean	Thermostat Control		0,00	1,00
r21 Cutout2 temp	R/W	Float	Thermostat Control	celsius	-50,00	50,00
o17 Disp. 54 %	R/W	Integer	Thermostat Control	percent	0,00	100,00
r04 Disp. Adj. K	R/W	Float	Thermostat Control		-10,00	10,00
r16 MeltInterval	R/W	Integer	Thermostat Control	hour	0,00	10,00
r17 Melt period	R/W	Integer	Thermostat Control	minute	0,00	10,00
u90 Cutin temp.	R	Float	Thermostat Control	celsius	-32767,00	32767,00
u91 Cutout temp.	R	Float	Thermostat Control	celsius	-32767,00	32767,00
u56 Display air	R	Float	Thermostat Control	celsius	-32767,00	32767,00
u18 Ther runtime	R	Integer	Thermostat Control	minute	-32767,00	32767,00
u13 Night Cond.	R	Boolean	Thermostat Control		-32767,00	32767,00
u86 Ther. band	R	Integer	Thermostat Control		1,00	2,00
n57 Pe/S1 select	R/W	Integer	Injection Control		1,00	2,00
o30 Refrigerant	R/W	Integer	Injection Control		1,00	31,00
o20 MinTransPres	R/W	Float	Injection Control	bar	-1,00	5,00
o21 MaxTransPres	R/W	Float	Injection Control	bar	6,00	36,00
n10 Min SH	R/W	Float	Injection Control	celsius	3,00	20,00
n09 Max SH	R/W	Float	Injection Control	celsius	3,00	20,00
n11 MOP temp.	R/W	Float	Injection Control	celsius	-50,00	15,00
n12 Glide	R/W	Float	Injection Control	kelvin	0,00	10,00
n13 AKV Period	R/W	Integer	Injection Control	second	3,00	6,00
n15 StartUp time	R/W	Integer	Injection Control	second	30,00	600,00
n23 MTR Kpfactor	R/W	Integer	Injection Control		1,00	50,00
n24 MTR Tn sec	R/W	Integer	Injection Control	second	100,00	1800,00
n16 AKV Dim.	R/W	Integer	Injection Control	percent	10,00	75,00

All the points of the device can be automatically discovered by clicking the button “Discover” and then dragged and dropped the desired ones into the Point database of the device.

**IMPORTANT:** all the devices are generated according to Danfoss specifications. Particularly they have the same Point Name as in the original Danfoss device, Data Type, Group according to Danfoss documentation, Unit of Measurements and real-time values.

Some points like the set-points have read-write characteristics and this allow their remote management by means of the Tridium technology.

## 11 Configuration

To perform point discovery the driver uses the "alvasysAkIp" folder on the Jace. This folder has to be created and the templates have to be copied into it as the picture shows.

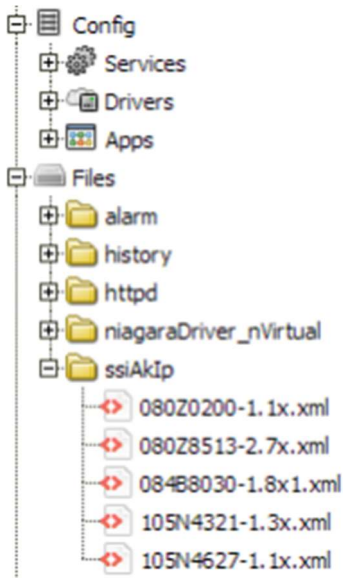

The point discovery shows groups. These are expandable and show the points under the groups.

Ssi Adap Kool I P Discovery Success >> [X]

Discovered 248 objects

Point Name	Mode	Data Type	Group	Unit	Min	Max
Ctrl function	R/W	Boolean	Defrost groups - Defrost group 8		0.00	1.00
Manuel start	R/W	Boolean	Defrost groups - Defrost group 8		0.00	1.00
Coordinated defrost	R/W	Boolean	Defrost groups - Defrost group 8		0.00	1.00
Start via DI	R/W	Boolean	Defrost groups - Defrost group 8		0.00	1.00
Status DI override	R	Boolean	Defrost groups - Defrost group 8		0.00	1.00
Last duration time	R	Integer	Defrost groups - Defrost group 8	minute	0.00	65536.00
DI override status	R	Boolean	Defrost groups - Defrost group 8		0.00	1.00
Defrost status	R	Boolean	Defrost groups - Defrost group 8		0.00	1.00